

TAKSTAR® 得胜



E500W 无线扩音器
Wireless Amplifier

使用手册 User Manual

E500W 无线扩音器

■ 前言

尊敬的用户：

感谢您选购得胜E500W无线扩音器，为了您能够更好的了解使用本产品，建议您在使用前仔细阅读本说明书。

若存在有疑问或者您有宝贵的建议，可通过拨打得胜官方服务热线400 6828 333或微信扫描二维码关注得胜官方公众号与我们联系。



■ 产品特性

- 一款大功率无线扩音器，双音圈强磁喇叭，20W功率，音质好，声音大
- 采用UHF无线技术，在无干扰、无障碍下使用距离约40米
- 可调频，40个精选频道（A通道有01-20频道，B通道有21-40频道），支持多套扩音器同时使用
- 内置双无线模块，支持双麦同时使用，配备可充电无线手持或无线头戴麦克风，操作简便，抗干扰强
- 内置DSP啸叫抑制芯片，有效抑制啸叫声
- 具备无线播放功能，简化繁琐的线材连接，无线播放音乐更自由
- 支持多种音频播放，支持U盘、TF卡、音频输入功能
- 配备显示屏显示设计，实时了解扩音器工作状态
- 内置大容量锂电池，节能环保，使用时间约12小时（80%的音量扩音）
- 具有肩挂及腰挂等多种佩戴方式，使用更方便
- 产品依照人体工学原理设计，造型新颖，外观时尚

■ 适用范围

- 适用于教学、会议、培训、导览、促销、等场合

E500W 无线扩音器

■ 产品配置

E500W扩音器.....	1个
无线手持麦克风.....	2个 (选配)
无线头戴麦克风.....	2个 (选配)
有线头戴麦克风.....	1个 (选配)
肩带.....	1条
Type-C充电线.....	1条
说明书.....	1份

■ 技术参数

主机参数

- 频率响应：80Hz-18KHz
- 额定功率：10W
- 峰值功率：20W
- 扬声器阻抗：4 Ω
- 工作电压：DC 6.4-8.4V
- 电池规格：3.7V/2500mAh*2
- 充电电压：DC 5V/1A
- 充电时间：约2.5小时
- 使用时间：约12小时（80%的音量扩音）
- 单机重量：约420g
- 产品规格：130x102x46mm

发射参数（无线手持麦克风）

- 拾音器：背极式驻极体
- 指向性：单指向
- 频率响应：60Hz-16KHz
- 灵敏度：-51至-54dB
(0db=1V/Pa/m at 1kHz)
- UHF频率：657.3MHz-667.05 (分段)
- UHF使用距离：空旷地带约40米
- 电池类型：锂离子电池
- 电池容量：18650单节3.7V/2000mAh
- 充电规格：DC 5V/1A
- 充电时间：约2.5小时
- 使用时间：约20小时
- 净重：约150g

E500W 无线扩音器

发射参数 (无线头戴麦克风)

- 拾音器：背极式驻极体
- 指向性：单指向
- 频率响应：60Hz-16KHz
- 灵敏度：-44至-50dB(0db=1V/Pa/m at 1kHz)
- UHF使用距离：空旷地带约40米
- 电池类型：锂离子电池
- 电池容量：3.7V/400mAh
- 充电规格：DC 5V/300mA
- 充电时间：约2小时
- 使用时间：约4小时
- 净重：约39g







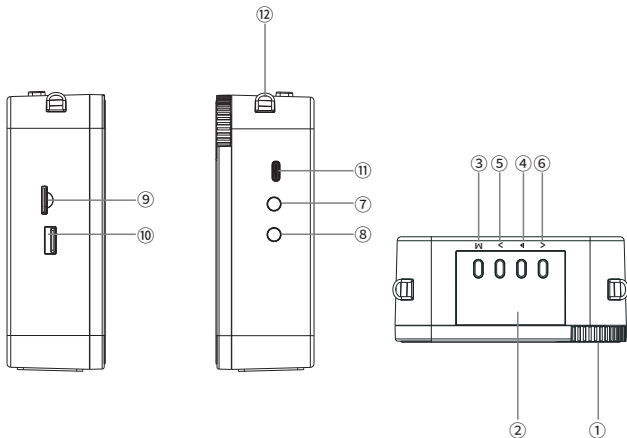

注：以上数据由得胜实验室测试得到，并拥有最终解释权！

■ 功能示意

扩音器



E500W 无线扩音器

- ① 电源开关：向MAX方向拨动旋钮，听到“哒”一声，同时LED数码显示屏出现“UHF”，表示扩音器已通电并进入人声扩音状态，继续向MAX方向拨动旋钮声音增大，反之向“OFF”方向拨动旋钮则声音减小，直至听到“哒”的一声关机。
- ② LED数码显示屏：显示当前的工作模式、电池电量、麦克风工作频道等信息，显示“BLUE”时为蓝牙模式、显示“HLOH”为K歌模式、显示“TF”为TF卡模式、显示“USB”为USB模式、显示“AUX”为音频输入模式、“显示“REC”为录音模式（注：需要插入存储器和连接麦克风时才能切换到录音模式）。为电池电量符号，当电量符号闪烁时（扩音器电量低于1小时，电量符号开始闪烁），表示电池电量较低，需及时充电；显示屏出现“———”符号，表示扩音器进入待机状态，按任意键即可唤醒。
- ③ “M”模式切换键：开机状态下，短按该按键可切换工作模式，并伴随相应的语音提示，有六种工作模式。在K歌模式状态下，长按“M”键，可进行小混响、中混响、大混响模式调节。当接入AUX音源或插入TF卡时，以音频输入模式或TF卡模式为优先，当拔掉AUX音源或退出TF卡时，跳转到下一个工作模式；在插有存储器及接通麦克风的情况下，长按此键进入录音模式并且显示屏出现“REC”符号及语音提示“录音模式”。录音过程显示屏“00:00”数值变动，表示录音时长，录制完成时长按此键可退出并保存录音。退出录音模式后，会自动循环播放刚才的录音。
- ④ 播放/暂停按键：短按该按键控制音乐的播放及暂停。在蓝牙播放时，长按此键可以断开蓝牙连接，并语音提示“蓝牙已断开”，再次长按此键重新回连蓝牙信号，并有语音提示“蓝牙已连接”；在TF卡模式或USB模式下播放音乐时，长按此键出现()单曲循环符号，进入单曲循环播放状态，再次长按此键，()符号消失，退出当前单曲循环播放。
- ⑤  下一曲按键：短按切换下一曲。
- ⑥  上一曲按键：短按切换上一曲。
- ⑦  MIC输入接口：将有线麦克风插头插入此孔，进入有线人声扩音状态。
- ⑧  AUX输入接口：通过Ø3.5mm音频连接线与手机、平板、MP3等播放设备连接，可将扩音器作为有源音箱使用。

E500W 无线扩音器

⑨  TF卡插槽：根据示意的插卡方向插入TF内存卡。插入时，听到“哒”一声，表示已安装到位；取卡时将卡往下按压，听到“哒”一声，TF内存卡将自动弹出。

提示：请确保TF卡中储存的是MP3、WAV格式的音频文件，否则不能正常读取歌曲文件甚至会有损坏机器的风险；拷入歌曲前请先将TF卡按FAT16、FAT32格式进行格式化，其它方式的格式化（如exFAT、NTFS格式）会导致录音无法保存或者储存的歌曲无法播放。

⑩ USB接口：可插入U盘播放音频文件。

⑪ 充电接口：通过Type-C充电线为扩音器充电。

⑫ 挂扣：用于安装肩带，可将扩音器挂于肩上使用。

手持麦克风

① 电源键：长按该按键开启/关闭麦克风；开机状态下，双击该按键，则麦克风进入对频状态；短按该按键1下，则麦克风进入变频状态，关机状态下，长按该按键10秒后，A/B通道切换（A通道手持麦克风长按10秒后切换到B通道使用，B通道手持麦克风长按10秒后切换到A通道使用）

注：A/B通道切换此功能适用于双通道，单通道无此功能。

② 指示灯：开机状态下，指示灯显示绿灯，表示麦克风电量正常；指示红灯闪烁时，表示麦克风电量不足，请及时为麦克风充电；充电时，指示灯红灯常亮；绿灯长亮，表示电已充满。麦克风开机状态下，双击电源键，并伴随指示灯绿灯闪烁，表示麦克风处于对频状态；对频成功后，指示灯恢复绿灯常亮。麦克风关机状态下，长按电源键10秒后绿灯闪烁，表示处于通道切换状态，指示灯恢复绿灯常亮，表示通道切换成功。

③ 充电接口：通过Type-C充电线为麦克风充电。

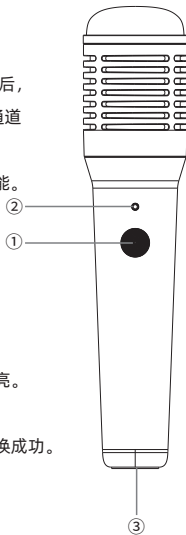

头戴麦克风

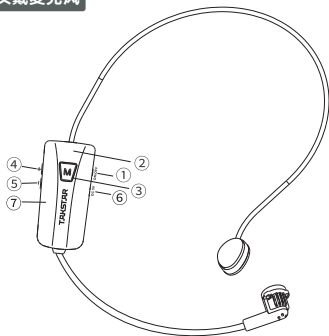

头戴麦克风

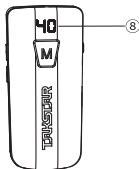

显示屏

- ① 电源开关：拨动开关至ON时开机，拨开关至OFF时关机；
- ② 显示屏：显示当前工作频道、麦克风音量、功率切换等状态；
- ③ M按键：用于调频操作，详见本说明书的“对频方法”部分；
- ④ “+” 按键：点按增加麦克风音量；在对频状态下，点按切换上一个频道；
- ⑤ “-” 按键：点按减少麦克风音量；在对频状态下，点按切换下一个频道；
- ⑥ 充电接口：连接USB数据线，请使用规范5V 1A且经过3C认证的充电头为扩音器充电；
- ⑦ 电源指示灯：关机未充电时，指示灯熄灭；开机时长亮蓝灯；电量充足时，指示灯常亮蓝灯；电量不足时，指示灯蓝灯闪烁，充电时红灯长亮，充满后红灯熄灭；
- ⑧ 工作频道/麦克风音量：默认显示当前工作频道，有A通道“01-20频道” B通道“21-40频道”，共40个工作频道；当点按音量+、-键时，则显示音量大小，有“U1-U9”共9级音量，3秒后回复正常数值；10秒后无任何操作，显示屏将自动熄灭。
- ⑨ 高低功率切换：同时点击“M”按键和“-”按键为低功率，同时显示屏会显示低功率的提示“E0”，同时点击“M”按键和“+”按键为高功率，同时显示屏会显示低功率的提示“E1”。（低功率无线使用距离在10米左右，高功率无线使用距离在40米左右）

■ 使用说明

一、对频方法

产品出厂时已默认配对好，开机自动连接，无需配对。如遇有信号干扰，可按下面方法进行重新配对或变频。

手持麦克风：

1.对频方法

① 长按两个麦克风的电源键开启麦克风，同时指示灯绿灯常亮，然后双击电源键，指示灯绿灯闪烁，则进入对频状态。此时立刻打开扩音器电源开关，等待手持麦克风绿灯从闪烁变成常亮时，对着麦克风说话有声音，表示配对成功；

② 如果对着手持麦克风说话没声音，即说明配对不成功，请按上面方法重新配对。

2.变频方法

① 同时打开扩音器及手持麦克风电源开关，配对成功后短按1次手持麦克风上的电源键进行变频，指示灯绿灯快速闪烁1下后恢复长亮，表示自动变频成功。

注：手持无线麦克风A共有“CH01-CH20”20组频道可供调节，手持无线麦克风B共有“CH21-CH40”20组频道可供调节。

头戴麦克风：

1.对频方法

① 首先确保头戴麦克风及扩音器都在关机状态。然后打开头戴麦克风电源开关，长按麦克风“M”键3秒，显示屏循环转圈时松开，此时立刻打开扩音器电源，等待麦克风的显示屏从转圈变为静态数值时，对着麦克风说话有声音，表示配对成功；如果麦克风进入对频状态后，10秒钟内没有打开扩音器电源开关，对频失败，显示屏从转圈变为静态数值。

② 对着头戴麦克风说话没声音，说明配对不成功，请按上面方法重新配对。

2.变频方法

① 确保在对频成功的情况下，同时打开扩音器及头戴麦克风电源开关，短按头戴麦克风上的“M”键进入变频，显示屏数值闪烁，此时点按音量“+”“-”键切换上、下频率，点按M键确认频率，如3秒钟无操作M键确认，频率停止闪烁固定在当前选择的频率。

二、蓝牙配对

首次使用本机时，需要与手机或蓝牙设备配对连接，步骤如下：

- ① 先打开扩音器电源开关，点按“M”键切换成蓝牙模式，显示屏出现“BLUE”符号且闪烁时，表示蓝牙正在搜索配对状态；
- ② 进入手机“设置”菜单，找到蓝牙功能选项，开启手机的蓝牙功能，待搜索到“TAKSTAR E500W”，点击“TAKSTAR E500W”进行连接，当扩音器出现提示音“蓝牙已连接”，表示蓝牙连接成功，手机、笔记本、平板、IPAD等设备蓝牙连接产品成功后，可实现播放音乐功能。
- ③ 下次开机后点按M键开启蓝牙模式时，将自动回连最后一次使用的蓝牙设备，并提示“蓝牙已连接”。

■ 安全警示

为避免电击、高温、着火、辐射、爆炸、机械危险以及使用不当等可能造成的人身伤害或财产损失，使用本产品前，请仔细阅读并遵守以下事项：

1. 使用产品时请确认所连设备与本产品是否匹配以及合理调整音量大小，不要在超过产品功率及大音量下长时间使用，以免造成产品异常；
2. 使用中若发现有异常（如冒烟、异味等），请立即关闭电源开关并拔掉电源插头，然后将产品送售后服务网点检修；
3. 消费者若使用电源适配器供电，则应购买配套使用获得CCC认证并满足标准要求的电源适配器；
4. 本产品及配件都应放置在室内干燥通风处，请勿长期存放在潮湿、灰尘多的环境，使用中避免靠近火源、雨淋、进水、过度碰撞、抛掷、振动本机及覆盖通风孔，以免损坏其功能；
5. 若产品需要固定于墙壁或天花板时，请确保固定到位，防止因固定强度不足导致产品发生跌落危险；
6. 使用该产品时需遵守相关安全规定，法律法规明确禁止使用场合请勿使用本产品，以免导致意外事故；
7. 请不要自行拆机改装或维修，以防止出现人身伤害，如有问题或服务需求请联系当地售后服务网点跟进处理。

■ 关于图标含义解释



此符号表示，根据WEEE指令(2012/19/EU)和国家法律，由于这种类型的废弃物会有潜在的有害物质，可能对环境 and 人类健康产生负面影响，所以本产品不应与您的家庭垃圾一起处置，应将本产品交由授权的电气和电子设备（WEEE）回收站回收。同时，您在正确处理本产品的同时将有助于自然资源的有效利用。如需了解更多有关您可以在何处放置废物回收设备的信息，请联系您当地的城市办事处、废物管理局或家庭废物处理服务部门。

环保说明

产品中有毒有害物质或元素的名称及含量标识表

部件名称	有毒有害物质或元素					
	铅 (Pb)	汞 (Hg)	镉 (Cd)	六价铬 (Cr(VI))	多溴联苯 (PBB)	多溴二苯醚 (PBDE)
塑料部件	○	○	○	○	○	○
金属部件	×	○	○	○	○	○
电路板组件	×	○	○	○	○	○
线缆	×	○	○	○	○	○

本表格依据SJ/T 11364的规定编制。
○: 表示该有害物质在该部件所有均质材料中的含量均在 GB/T 26572 规定的限量要求以下。
×: 表示该有害物质至少在该部件的某一均质材料中的含量超出 GB/T 26572 规定的限量要求。

此标志为产品的环保使用期限标志，
且此环保使用期限只适用于产品正常工作的温度和湿度等条件。

■ 关于本说明书

本说明书中内容符合截止印刷之日的技术规格。由于得胜公司会不断改进产品，本说明书可能不符合您的特定产品的技术规格。要获取最新版说明书，请访问得胜官网，然后下载说明书文件。技术规格、设备或另售的附件在各个地区可能有所不同，如有问题请与当地得胜销售网点确认。如需更多支持和深层产品信息，请浏览得胜官方网站：

<https://www.takstar.com>

E500W Wireless Amplifier

■ Preface

Dear Customer,

Thank you for purchasing Takstar E500W Wireless Amplifier. In order to better understand and use the product, please read this manual carefully. If you have any questions or suggestions, please contact our local dealer.

■ Features

- Wireless amplifier with dual voice coil speaker, powerful magnet, 20W high power, and clear audio.
- UHF wireless technology, about 40m use range in area without obstruction and interference.
- 40 adjustable channels (Channel A: CH01-20; Channel B: CH21-40), and ability to use multiple sets simultaneously.
- Built-in anti-interference wireless module for dual mic application. Optional rechargeable handheld or headset mics.
- Digital Signal Processor (DSP) chip inside effectively suppresses feedback.
- Wireless playback for a simpler music experience untethered by tedious wiring.
- Support a variety of audio inputs including USB drive, TF card and AUX inputs.
- Equipped with an LED display for clear overview of amplifier status in real time.
- Built-in large-capacity lithium-ion battery lasts around 12hrs operation (80% volume).
- Strap across shoulder or around waist, any way you like.
- Stylish, designed in accordance with ergonomic principles.

■ Application

- Teaching, meeting, training, tour guide, sales, etc.

E500W Wireless Amplifier

■ Package Contents

E500W Amplifier.....	1 PCS
Wireless Handheld Microphone.....	2 PCS (optional)
Wireless Headset Microphone.....	2 PCS (optional)
Wired Headset Microphone.....	1 PCS (optional)
Shoulder Strap.....	1 PCS
Type-C Charging Cable.....	1 PCS
User Manual.....	1 PCS

■ Specifications

Amplifier

- Frequency Response: 80Hz-18KHz
- Rated Power: 10W
- Peak Power: 20W
- Speaker Impedance: 4Ω
- Operating Voltage: DC 6.4-8.4V
- Battery: 18650, 3.7V/2500mAh * 2PCS
- Charging Voltage: DC 5V/1A
- Charging Time: about 2.5 hours
- Playtime: about 12 hours (80% volume)
- Net Weight: about 420g
- Dimensions: 130×102×46mm

Transmitter (Wireless Handheld Mic)

- Capsule: back electret
- Polar Pattern: unidirectional
- Frequency Response: 60Hz-16KHz
- Battery Type: lithium-ion battery
- Sensitivity: -51 to -54dB (0db=1V/Pa/m at 1kHz)
- UHF Frequency: 657.3MHz-667.05MHz (segmented)
- UHF Use Distance: about 40m in open area
- Battery Capacity: 18650, 3.7V/2000mAh * 1 PC.
- Charging Specification: DC 5V/1A
- Charging Time: about 2.5 hours
- Playtime: about 20 hours
- Net Weight: about 150g

E500W Wireless Amplifier

Transmitter (Wireless Headset Mic)

- Capsule: back electret
- Polar Pattern: unidirectional
- Frequency Response: 60Hz-16KHz
- Sensitivity: -44 to -50dB
(0db=1V/Pa/m at 1kHz)
- Battery Type: lithium-ion battery
- UHF Use Distance: about 40m in open area
- Battery Capacity: 3.7V/400mAh
- Charging Specification: DC 5V/300mA
- Charging Time: about 2 hours
- Playtime: about 4 hours
- Net Weight: about 39g

Note :The above data are measured by Takstar laboratory which has the final interpretation right!

■ Function Descriptions



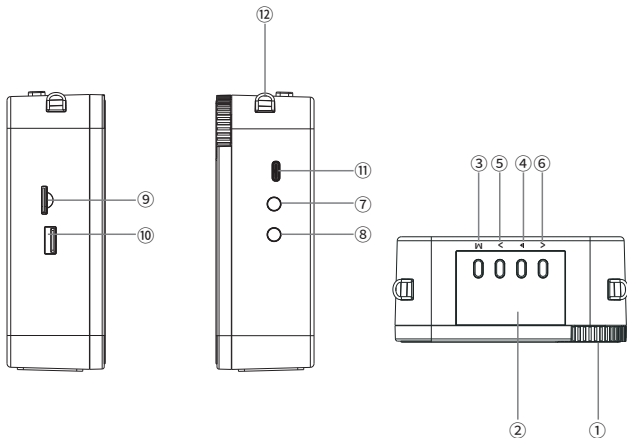

Voice Amplifier



E500W Wireless Amplifier

- ① Power switch: rotate the dial to MAX until you hear a click to power on the device and then gradually increase the volume level. Once powered on, the LED display shows “UHF”, meaning the device is ready for voice amplification. Likewise, rotate to OFF to gradually decrease the volume level and eventually power off the device when you hear a click.
- ② LED digital display: display information such as the current work mode, battery level and mic working channel. It shows “BLUE” in Bluetooth mode, “HLOH” in karaoke mode, “TF” in TF card mode, “USB” in USB mode, “AUX” in audio input mode, and “REC” in recording mode (Note: you can only switch to recording mode when a storage device and a mic are both connected).  is the battery level symbol which flashes when power is low (less than 1 hour left) and requires charging in time. “— — — —” shows up when the amplifier is in standby status which can be wakened up by any key press.
- ③ M mode button: when powered on, press it to switch among six work modes, accompanied by corresponding voice prompt. In karaoke mode, long press M button to switch among low-reverb, medium-reverb and high-reverb settings. Once an AUX audio source or a TF card is inserted, the device will automatically switch to AUX mode or TF mode, and upon disconnected, switch to the next work mode. While a storage device and a mic are connected, long press this button to enter recording mode, accompanied by a “REC” symbol on LED display and a “Recording mode” voice prompt. During recording, the LED display shows recording duration in “00:00” format. Long press this button again to exit and save recording. Upon exiting recording mode, the device will automatically play the newly recorded audio in a loop.

E500W Wireless Amplifier

- ④  Play/Pause button: press it to play or pause the music. When playing in Bluetooth, long press this button to disconnect Bluetooth, followed by a voice prompt "Bluetooth disconnected" ; long press this button again to reconnect Bluetooth, followed by a voice prompt "Bluetooth connected". When playing music in TF card mode or USB mode, long press this button to loop a single song, accompanied by a single loop symbol (↺) ; long press this button again to cancel single-song loop, and the symbol (↺) will disappear.
- ⑤  Next track button: press to switch the next track.
- ⑥  Previous track button: press to switch to the previous track.
- ⑦  MIC input interface: insert a wired mic to start wired voice amplification.
- ⑧  AUX input interface: connect to a playback device (e.g., phone, tablet, MP3 player) via a Ø3.5mm audio cable, so to use the amplifier as an active speaker.
- ⑨ TF card slot: insert a TF memory card following the labeled direction until you hear a click to install it in place. To remove the TF card, press it down until it clicks to eject the card.

Tip: Please make sure the audio files in the TF card are stored in MP3 and/or WAV format, otherwise it won't be readable and may even damage the device. Please format the TF card to FAT16 or FAT32 file system before copying songs, because other file system (e.g., exFAT, NTFS) will cause failure to save recordings or play songs.
- ⑩ USB interface: insert a USB flash drive to play audio files.
- ⑪ Charging port: charge the amplifier via a Type-C charging cable.
- ⑫ Strap clip: used to install the shoulder strap for wearing the amplifier across shoulder.

E500W Wireless Amplifier

Handheld Microphone

① Power button: long press it to turn on/off the mic.

When powered on, press it twice to start pairing, or press it once to change frequency. When powered off, long press it for 10 seconds to switch between A/B channel. Note: A/B channel switching is only applicable for the dual-channel model, not for the single-channel model.

② Indicator light: lights up green when powered on and battery level is normal; flashes red if low power and requires charging; illuminates solid red while charging and turns solid green when fully charged.

When the mic is powered off, long press its power button for 10 seconds until the indicator flashes green to switch channel A/B, and once switched successfully, the indicator will resume solid green.

③ Charging port: charge the mic via a Type-C charging cable.

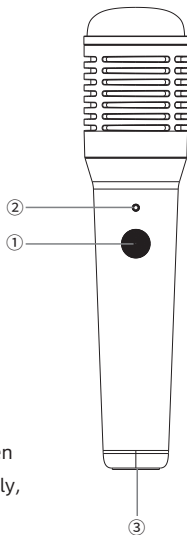

Headset Microphone

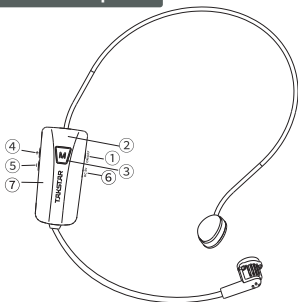

Headset Mic

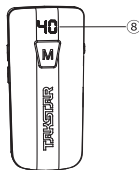

LED Display

E500W Wireless Amplifier

- ① Power switch: toggle switch to ON or OFF to power on or off respectively.
- ② Display: display working channel, mic volume and power status.
- ③ M button: used for changing frequency, refer to “Pairing Method” section for details.
- ④ [+] button: press to increase mic volume. In pairing mode, press or long press to gradually.
- ⑤ [-] button: press to decrease mic volume. In pairing mode, press or long press to gradually.
- ⑥ Charging port: connect to a USB data cable. Please use a standard 3C-certified 5V/1A adapter to charge the amplifier.
- ⑦ Power indicator: light's off when the power is off and not charging; lights up solid blue when powered on and power is sufficient; flashes blue if low power; illuminates solid red while charging and no longer red when fully charged.
- ⑧ Working channel/mic volume: display the current operating channel by default. There are 40 available channels in total. Channel A can set CH01-20, while Channel B can set CH21-40. Volume level is displayed for 3s when you press volume [+]/[-] button, 9 levels in total, “U1-U9” . LED display goes off automatically after 10s
- ⑨ High/Low power switch: press both [M] and [-] buttons at the same time to switch to low power, LED display shows E0; or press both [M] and [+] to switch to high power, LED display shows E1. (Use distance is around 10m when set to low power, or around 40m when set to high power)

■ Operation Instructions

A. Pairing Method

The products are paired by factory default and will automatically connect to each other once powered on. No extra pairing is required. If there is signal interference, follow the below steps to re-pair or change frequency:

Handheld Microphone:

1. Pairing Method

① Power up both mics by long pressing their power buttons, their LED indicator should light up green. Then press their power buttons twice to enter pairing mode, indicated by flashing green LED indicator. Meanwhile, immediately power up the amplifier, wait until the flashing LED on handheld mic turns solid green to finish pairing. You should be able to hear voice amplification when talking to the mic.

② If there is no sound when you talk to the handheld mic, that means the pairing is not successful, please retry the above steps to re-pair.

2. Changing Frequency

① Power up both the amplifier and handheld mic. After successfully paired, press the power button on the mic once to change frequency. If successful, the green indicator should flash for 1s before resuming solid green.

Note: Wireless handheld mic A & B each has 20 adjustable frequency channels.
Mic A: CH01-CH02; Mic B: CH21-CH40.

Headset Microphone:

1. Pairing Method

① First, power off both the headset mic and the amplifier. Next, power up the headset mic, long press mic [M] button for 3s until its LED display shows a circle. Then, immediately power up the amplifier, wait until the headset mic's LED circle changes into a static number. Talk towards the mic to test if your voice is amplified and if pairing is successful.

E500W Wireless Amplifier

If the amplifier is not powered on within 10s after the mic enters pairing mode, the mic will exit pairing mode and its LED circle will change back to a static number.

No sound when talking to the headset mic means the pairing is not successful, please retry.

2. Changing Frequency

① Make sure that the headset mic and the amplifier are already paired, then power up both devices at the same time. Press the mic [M] button to change frequency, and the channel number on headset LED display will flicker. Then, press volume [+]/[-] button to cycle through frequency, and press [M] again to confirm frequency, or leave it auto confirmed after 3s idleness.

B. Bluetooth Pairing

Upon first use, you need to connect this device to your phone or Bluetooth device, following below steps:

① Power up the amplifier, press [M] to switch to Bluetooth mode and start Bluetooth discovery and pairing, indicated by a blinking “BLUE” symbol.

② Enter SETTINGS menu on your phone, find and enable Bluetooth, wait until “TAKSTAR E500W” is discovered and tap on it to connect. When connected successfully, there will be a voice prompt about “Bluetooth Connected” . Devices such as cell phones, laptops, tablets, and iPads can play music via Bluetooth thereafter.

③ The next time you switch to Bluetooth mode, the amplifier will automatically connect to the previously paired device, signaled by a voice prompt “Bluetooth connected” .

■ Safety Instructions

To avoid electric shock, overheat, fire, radiation, explosion, mechanical risk and injury or property loss due to improper use, please read and observe the following items before use:

1. Please check if the power of the connected equipment matches with that of this product before operation. Adjust the volume to proper level during operation. Do not operate at over-power or high-volume level for extended time to avoid product malfunction.
2. If there is any abnormality during use (e.g., smoke, strange odor), please kill the power switch and unplug from power source, then send the product to the local after-sales service for repair.
3. Power adapter used, if any, should be approved by CCC certification or similar standards and comply with the power supply requirements.
4. Keep this product and its accessories in a dry and ventilated area. Do not store in a humid or dusty area for extended time. Keep away from fire, rain, liquid intrusion, bumping, throwing, vibrating, or from blocking any ventilation openings, to prevent malfunction.
5. The product must, when installed on walls or ceilings, be fixed firmly in place at adequate strength to prevent from falling.
6. Please abide by safety rules during operation. Do not use the product in places prohibited by laws or regulations to avoid accident.
7. Do not disassemble or repair the product by yourself to avoid injury. If you have any questions or require any services, please contact our local after-sales service.

■ Label Meanings



This symbol indicates that this product should not be disposed of with your household waste, according to the WEEE directive (2012/19/EU) and your national law. This product should be handed over to an authorized collection site for recycling waste electrical and electronic equipment (WEEE). Improper handling of this type of waste could have a possible negative impact on the environment and human health due to potentially hazardous substances that are generally associated with WEEE. At the same time, your cooperation in the correct disposal of this product will contribute to the effective usage of natural resources. For more information about where you can drop off your waste equipment for recycling, please contact your local city office, waste authority, or your household waste disposal service.

■ About This Manual

This manual contains up-to-date technical specifications as of printing. However, specifications contained herein may not conform to your particular product since Takstar is constantly improving its products. Also, specifications, devices or accessories available may vary from region to region. If you have any questions, please contact our local sales outlet. For the latest version/more information, please visit our website: <https://www.takstar.com/>

注意事项：

1. 本单为保修凭证，请用户妥善保管，如有遗失，恕不保修或退换。
2. 保修期限制：购买之日起十二个月内。
3. 除了不可抗力事件损坏外，由本公司负责，免费维修。
4. 如属保管不善或使用不当造成的损坏，维修点将酌情收费。
5. 擅自拆卸维修者，不予保修。
6. 以上保修条款仅限于中国市场适用（不含港澳台地区）。

产品服务保证书

姓名：_____ 电话：_____ 地址：_____

商品：_____ 型号：_____ 购买日期：_____ 年 ___ 月 ___ 日

维修记录栏 (由维修员填写)	维修员签名	日期

◆广东得胜电子有限公司 ◆电话：400-6828-333 ◆地址：广东省惠州市博罗县龙溪街道富康一路2号



扫一扫，了解更多产品
Scan for more
product information

广东省电声工程技术研究开发中心 广东得胜电子有限公司制造

地址：广东省惠州市博罗县龙溪街道富康一路2号
服务热线：400 6828 333 传真：0752 6383950
邮箱：xs@takstar.com
网址：www.takstar.com

Guangdong Takstar Electronic Co., Ltd.
Address: No. 2 Fu Kang Yi Rd., Longxi Boluo
Huizhou, Guangdong 516121 China
Tel: 86 752 6383644 Fax: 86 752 6383952
Email: sales@takstar.com
Website: www.takstar.com